

THIN STEEL PLATE ETCHING

2. Developing

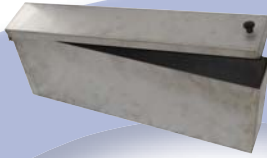

1. Exposure

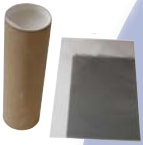

3. Etching



**Teca-Print
Thin Steel Plates**

Thin Steel Plates
ready for printing



4. De-layering



USE AND FEATURES OF THIN STEEL PLATES

In pad printing, thin steel plates are used for small to medium-sized production runs. Thin steel plates are very cost effective, easy to etch and provide good printing results.

Through development and tests, Teca-Print AG has proven out a range of products to optimize thin steel plate etching. For the best results - whether in terms of etching or print quality - it is critical that all products used in the etching process are carefully chosen and matched together. We are pleased that Teca-Print can now offer such a complete range of products and materials for the entire thin steel plate etching process.

Teca-Print thin steel plates are available in all commonly demanded plate sizes, whether un-punched or with punched holes for Sealed Ink Well printing systems.

Please note that on delivery and during the etching process, thin steel plates are very light-sensitive.

Teca-Print thin steel plates are double-side coated so that both sides can be etched.

THIN STEEL PLATE ETCHING

1. EXPOSURE

Peel off protective foil from the thin steel plate. The mat positive film, with the print image side down, is now placed on the plate which is then exposed to UV-light in the exposure units BG 25/30, BG 35/50 or BG 35/100.

For larger print images, we recommend that our screen film F 6380 with 80 lines/cm be used.

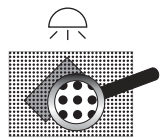

2. DEVELOPING

Immediately after UV-light exposure, the thin steel plates are developed for 2 minutes in a chrome steel tank filled with Granosol GR under gentle stirring movements.

There are various sizes of chrome steel tanks and immersion tools available for this purpose (see table).

The plates are then rinsed with water from top to bottom and dried with compressed air. We recommend a drying time of 5 to 10 minutes at 60 to 70°C in our drying cabinets TS 25/30, TS 35/50 or TS 35/100.

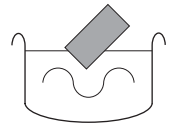

Retouching: Areas on the plate surface that have not been properly hardened during UV-light exposure can be protected from being etched off by covering them with red retouching varnish. For fine retouching, the etchproof masking pen can be used.

3. ETCHING

Thin steel plates are etched in a salt solution of 5 parts of water and 1 part etching salt. The etching salt must be completely dissolved before the etching process can be begun. For optimum etching results, the salt solution temperature should be 32°C for unscreened plates and 38°C for screened plates.

The etching time should be between 2 and 2^{1/2} minutes for unscreened plates with an etching depth of 25 µm and about 3 to 3^{1/2} minutes for plates screened with screen film F6380. After the etching is complete, the plate must be rinsed with water.

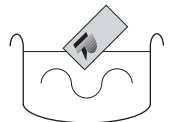

The etching salt solution can be used for about 3 to 5 weeks, after that time its etching power begins to gradually diminish. An aging process also takes place while the solution is not in use. Unused etching salt should be stored in the original container in a cool, dry place and at a safe distance to any organic products.

4. DE-LAYERING

Now the red retouching varnish that protected areas of the plate surface from the etching salt solution and the photolayer are removed. For this purpose, cleaner RE (or thinner VD) are applied, left on for a while to react with the residues on the plate surface, and are then removed mechanically using a brush. However, this will only work when the drying temperature (see step 2: Developing) did not exceed 70°C at any point.

Finally, the plate is rinsed with water and dried with compressed air.

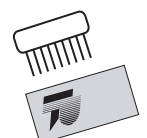

GENERAL INSTRUCTIONS



STORAGE

Thin steel plates can be protected from rusting by coating them with a fine layer of oil after every use.

Unexposed plates should be stored in a cool, dry place and storage time should not exceed 6 months.



ORDERING INFORMATION

Teca-Print thin steel plates are available **un-punched** for **open** ink well systems under the name **D05**. The designation for **punched** plates for use in **closed** ink well systems is **N05**. Be sure to always state the designations D05 or N05 in purchase orders and specify the plate size, e.g. D05 250 100 (un-punched plate for open ink well systems, size 250 x 100 mm) or N05 100 220 (punched plate for sealed ink well systems, size 100 x 220 mm).



D05: for open ink well system



N05: for sealed ink well system

One pack contains **5 unetched thin steel plates with double-sided coating**.

TECHNICAL DATA AND SAFETY DATA SHEETS

FOR FURTHER INFORMATION PLEASE CONSULT OUR TECHNICAL DATA SHEET ON THIN STEEL PLATE ETCHING. IT CONTAINS DETAILED INSTRUCTIONS AND GUIDELINES FOR THE ETCHING PROCESS.

Safety data sheets are available for all chemicals. It is essential that all **safety regulations** and **danger warnings** related to the respective chemicals are strictly observed.

LIST OF TECA-PRINT PRODUCTS FOR THIN STEEL PLATE ETCHING

Article No	Description	Type	Size / Contents / Remarks	Maximum plate size
90 00 53	Exposure unit	BG 25/30	520 x 200 x 460 mm	350 x 220 mm
90 00 07	Exposure unit	BG 35/50	760 x 180 x 550 mm	250 x 600 mm
90 00 55	Exposure unit	BG 35/100	1370 x 200 x 625 mm	320 x 1000 mm
90 00 54	Drying cabinet	TS 25/30	520 x 200 x 460 mm	350 x 220 mm
90 00 06	Drying cabinet	TS 35/50	760 x 180 x 550 mm	250 x 600 mm
90 00 56	Drying cabinet	TS 35/100	1370 x 193 x 625 mm	450 x 1300 mm
90 00 27	Screen film	F6380	130 x 180 mm	
90 00 28	Screen film	F6380	166 x 600 mm	
89 02 11	Developer	Granosol GR	1 Liter can	
55344 0003	Developer	Granosol GR	20 Liter steel barrel	
89 74 01	Retouching varnish red		0,5 Liter plastic bottle	
89 75 01	Etchproof masking pen		1 pen	
89 02 03	Etching unit	AG 35/22		350 x 220 mm
89 02 04	Etching unit	AG 60/25		600 x 250 mm
89 02 09	Etching salt		1 kg can	
89 02 10	Etching salt		5 kg bucket	
89 04 01	Chrome steel tank	B160	180 x 100 x 250 mm	160 x 200 mm
89 04 02	Chrome steel tank	B500	630 x 100 x 250 mm	600 x 200 mm
89 07 01	Immersion tool	TG 38	38 mm	
89 07 02	Immersion tool	TG 60	60 mm	
89 07 03	Immersion tool	TG 100	100 mm	
89 07 04	Immersion tool	TG 180	180 mm	
89 07 05	Immersion tool	TG 250	250 mm	
89 07 06	Immersion tool	TG 400	400 mm	
F91 00031 4	Cleaner	RE	1 Liter can	
F91 00031 5	Cleaner	RE	5 Liter canister	
F91 00031 8	Cleaner	RE	30 Liter canister	
F91 00001 4	Thinner	VD	1 Liter can	
F91 00001 5	Thinner	VD	5 Liter canister	

All devices listed above have a **main voltage** of **230V/50Hz**. If **115V/60Hz** is required, the exposure units BG 25/30 (No. 90 01 53) or BG 35/50 (No. 90 01 07) and the drying cabinets TS 25/30 (No. 90 01 54) or TS 35/50 (No. 90 01 06) may be used. For all other devices, use a **transformer** for 115V.



IMMERSION TOOL TG

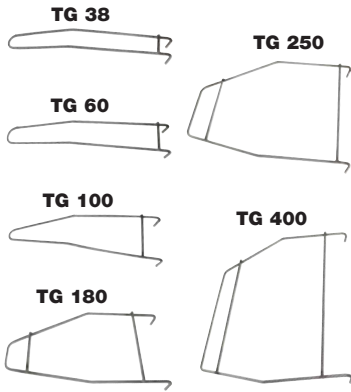

EXPOSURE UNIT BG DRYING CABINET TS



ETCHING UNIT AG



CHROME STEEL TANKS

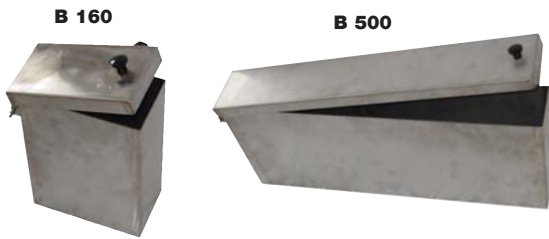

Etchproof
masking pen
89 07 05



Retouching varnish
(red)
89 07 05 (0,5L)



Screen film F6380



DEVELOPER GR



ETCHING SALT



THINNER VD



CLEANER RE



OTHER PLATE TYPES

The Teca-Print plate range includes - in addition to the thin steel plates - **steel and plastic plates** in all commonly demanded sizes.

Four types of plastic plates are available:

- quality standard water-rinsable
- quality standard alcohol-rinsable
- quality long-life water-rinsable
- quality long-life alcohol-rinsable

Further information on plastic, steel and thin steel plates is available on request or can be downloaded from our webpage www.teca-print.com

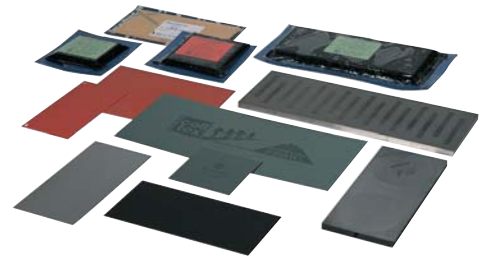

Visit our website for further information on Teca-Print plates and other pad printing products



www.padprinting.biz
www.tampographie.biz
www.tampondruck.biz
www.teca-print.com

Teca-Print

Teca-Print AG
Postfach
Bohlstrasse 17
CH-8240 Thayngen

Tel. +41 (0)52 645 2000
Fax +41 (0)52 645 2102
info@teca-print.ch
www.teca-print.com